

STROMER
POWER

Comprehensive Specification Sheet

Low-Voltage AC Alternator
Electrical and Mechanical Data



SP3-G40B3

50kVA Prime / 55kVA Standby
Three Phase / 50Hz / 4 pole

World-Class Alternators

Setting new standards in all aspects from design, manufacturing, material selection and production to testing equipment, tooling and quality control.

Tough: Our alternators are trusted as a component in the production of stationary diesel generator sets, mobile power plants and other power generation equipment which is supplied to various commercial, agricultural, refrigeration, residential, government and military services.

Trusted: Our product is highly regarded for its superior quality and performance. The alternators are used as the main power supply for three major satellite launch bases, for a station in Antarctica and for a spacecraft series.

Tested: Our products are thoroughly tested in different environments to ensure unsurpassed quality and reliability. Our stringent tests verify overall performance and align our products with most internationally-recognised standards.

Standards

- StromerPower alternators meet all key international standards and regulations
- The 4-pole alternator complies with the following major domestic and international standards and regulations: GB755, BS5000, IEC60034, VDE0530, CSAC22.2 100 and NEMA MG-1.22
- It is designed, manufactured and marketed in an ISO 9001 quality assurance environment
- Alternator can be integrated in CE-marked generator set

Electrical Characteristics and Performance

- Class H insulation
- 2/3 pitch winding
- **Voltage Range:** 50Hz: 220v - 240v and 380v - 415v (440v)
- High efficiency and motor starting capacity
- Low reactances

Specifications Overview

Three Phase / 50Hz / 400V / PF = 0.8			
Continuous 40°C		Standby 40°C	
kw	kVA	kw	kVA
40	50	44	55

Rated Frequency	Voltage	Voltage Regulation	Voltage Regulation Change	Phase Change Rate	Power Factor
Hz	v	v	% UN	%	
50	400	+/- 1%	< +/- 10	+/- 1	0.8

Insulation Class	Type	Phase and Connection	
H	Brushless	Three Phase	4 Pole

AVR Model	Stator	Rotor
SX460	2/3 Pitch	Single Bearing



Mechanical Construction

- StromerPower enclosures are IP23
- All rotors are dynamically balanced in strict accordance with the requirements of the ISO1940 standard
- Robust flanges and shields
- The large junction box makes wiring and adjustment of the AVR easier
- Space for current transformers or other optional modules to be installed
- Compact design and sturdy assembly to withstand generator vibrations
- All our alternators use long-term sealed bearings
- Steel base

Excitation System Regulations

- **Self-Excitation Standard**
- **Parallel Use:** When the appropriate modules (AVR, current transformer and control equipment) are installed, all 4-pole alternators can be used in parallel
- **Bearing Capacity:** NEMA specifications
- **Waveform:** According to the IEC standard, the total harmonic distortion rate is less than 5% under no-load or non-linear load. The telephone interference factor (TIF) is less than 50 in accordance with NEMA specifications
- **Frequency:** To be used at a frequency of 50Hz (standard windings) (No. B31, B32)
- **Power Factor:** The alternator is designed for loads with a power factor of 0.8

Single-Bearing Outline Schematic

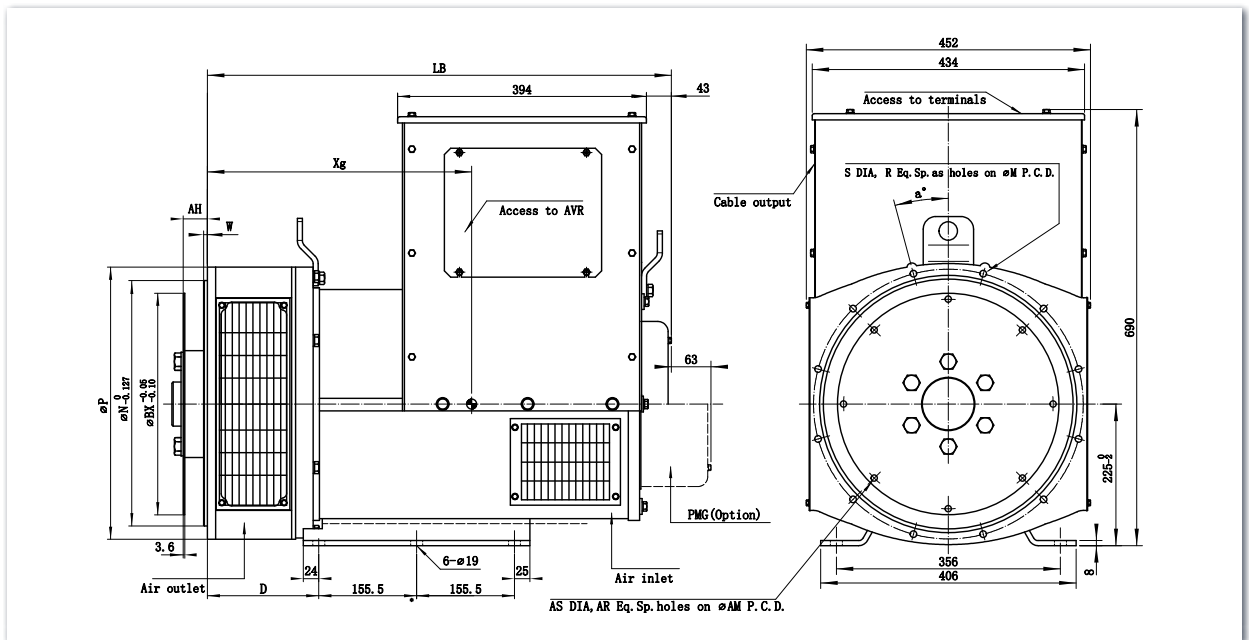

SAE Rating

Model	LB	LC	Xg	Weight
	SAE			kg
SP3-G40B3	647	394	321	239

Adapter

SAE	BX	AM	AR - øAS	AH
	mm			
11.5	352.425	333.38	8 - ø11	39.6

Flange

SAE	P	N	M	R - øS	W	D	a°
	mm						
3	451	409.575	428.625	12 - ø12	5	177	15

Torsional Analysis Data

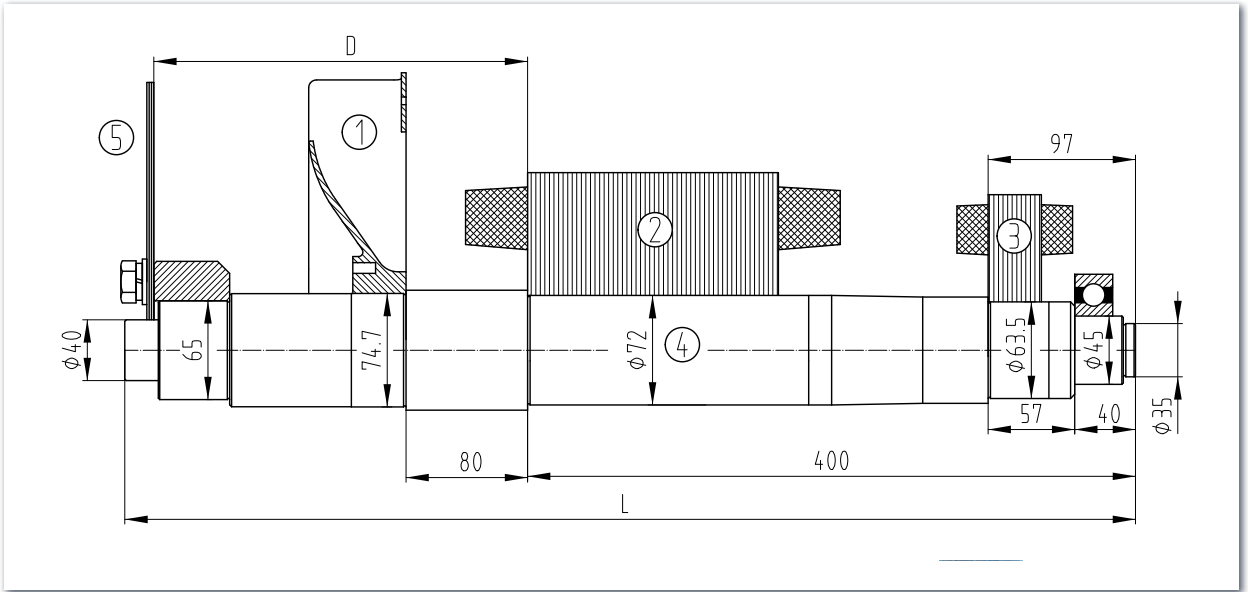

Fan		Main Rotor		Excitation Rotor		Shaft		Total	
Weight (kg)	J(kgm ²)	Weight (kg)	J(kgm ²)	Weight (kg)	J(kgm ²)	Weight (kg)	J(kgm ²)	Weight (kg)	J(kgm ²)
1.8	0.01	41.2	0.3651	10.0	0.0245	22.1	0.0097	75.1	0.4913

SAE	5	Shafts Coupling Flex Plate		
	D	L	Weight (kg)	J(kgm ²)
11.5	246	665	2.6	0.0337

Dimensions

Unpacked				Packed			
Length	Width	Height	Net Weight	Length	Width	Height	Gross Weight
mm			kg	mm			kg
705	452	690	239	795	540	890	266

STROMER

POWER

© StromerPower 2021

The information contained in this brochure is for guidance only and does not form part of any contract.

The accuracy cannot be guaranteed as StromerPower have an ongoing process of development and reserve the right to change the specification of their products without notice.

